



New range of TESA dial gauges

This new range brings together under the single TESA brand an 80-year history comprising of famous logos such as MERCER, ROCH, ETALON or COMPAC.

A wide range of applications are covered thanks to resolutions from 0,1 mm to 0,001 mm, combined with measuring ranges of up to 50 mm.

The yellow outline of the dial increases the contrast for better reading results.

Versions with a protection bellow and a waterproof screw-on dial are also available for use in demanding environments.



Main features:

- *Optimised yellow background for better reading results*
- *Shockproof system available to protect the mechanism*
- *IP67 and high-resolution versions with premium screw-on housing*
- *Numerous measuring key models available as accessories*

Product description

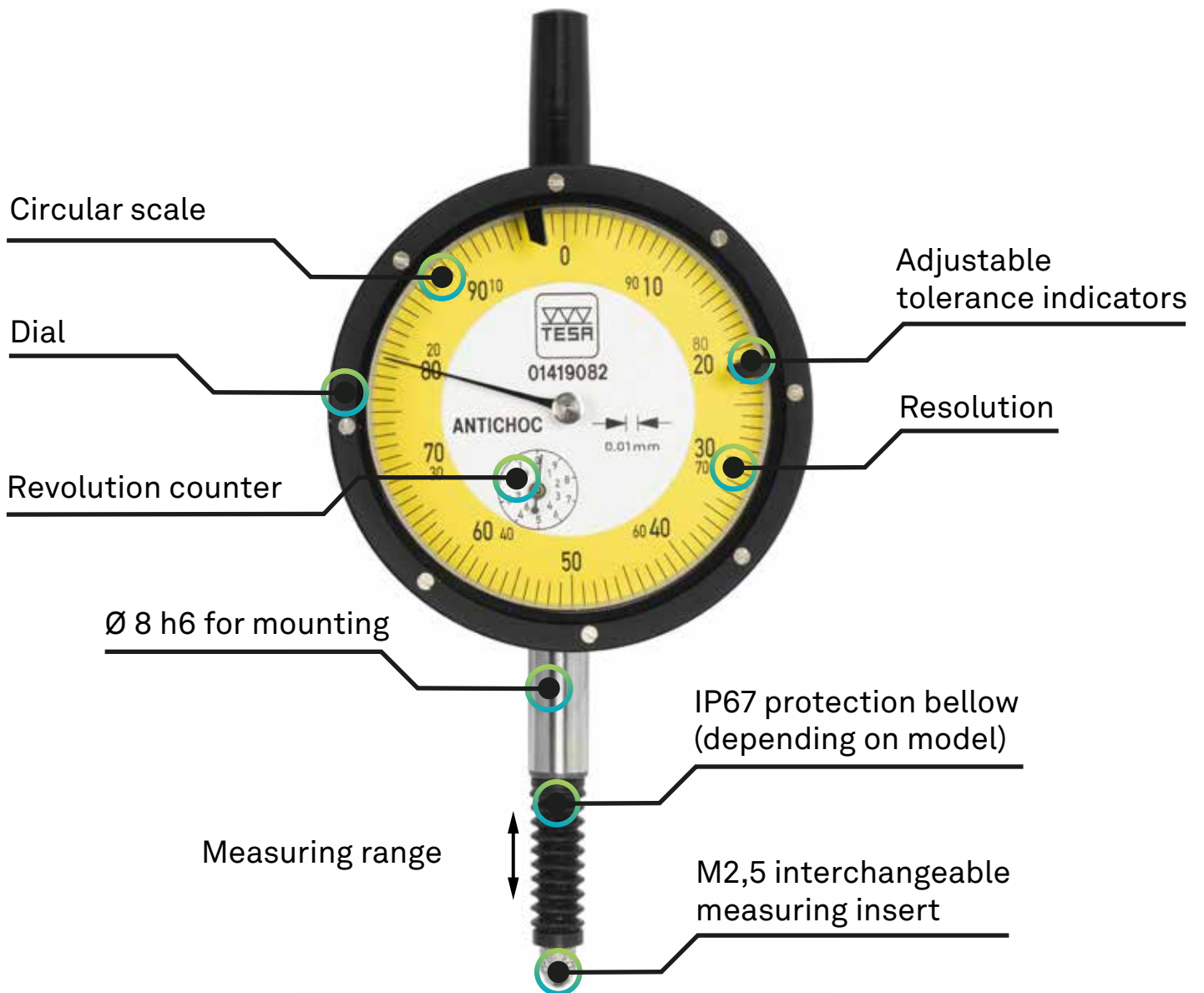

Specifications

Resolution 0,1 mm

Standard versions, measuring range 10 and 30 mm



0141760500



0141760501



0141760503

Ø Dial [mm]	Part number	Measuring range [mm]	Circular scale	Travel/lap [mm]	Degree of protection	Shockproof system	Measuring force [N]
40	0141760500 ⁽¹⁾	10	0-5-10	10	40	No	1,0 +/- 20%
58	0141760501 ⁽¹⁾	10	0-5-10	10	40	No	0,7 +/- 20%
58	0141760503 ⁽¹⁾	30	0-5-10	10	40	No	0,8 +/- 20%

Metrological characteristics according to EN ISO 463, vertical position:

Measuring range indication error	Indication error at 1/10 lap	Indication error at 1/2 lap	Indication error at 1 lap	Repeatability of indication error	Hysteresis of indication
MPE _{tot}	MPE _{1/10}	MPE _{1/2}	MPE ₁	MPE _R	MPE _H
[µm]	[µm]	[µm]	[µm]	[µm]	[µm]
50	30	40	45	15	15

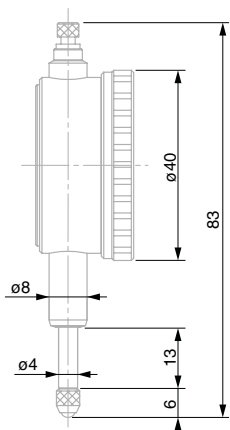

0141760500

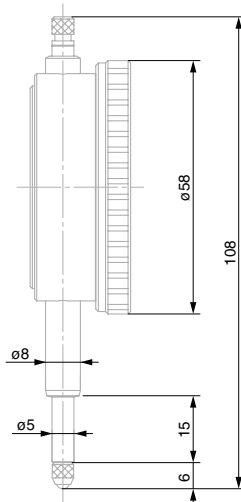

0141760501

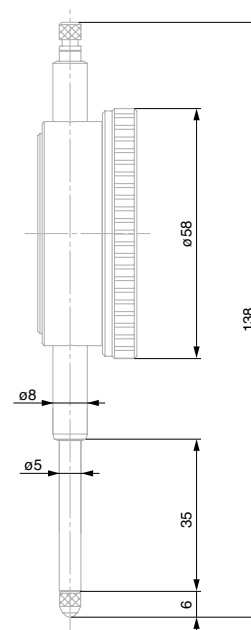

0141760503

(1): To date these models existed under the ROCH brand, and are now part of the TESA brand.

Resolution 0,01 mm

Standard versions, measuring range 5 and 10 mm



Ø Dial [mm]	Part number	Measuring range [mm]	Circular scale	Travel/lap [mm]	Degree of protection	Shockproof system	Measuring force [N]
40	01419047 ⁽²⁾	5	0-25-50	0,5	40	Yes	0,7 +/- 10%
44,5	01419081	5	0-25-50	0,5	67	Yes	0,9 +/- 20%
58	01419048 ⁽²⁾	10	0-50-100	1	40	Yes	0,7 +/- 20%
61,5	01419082	10	0-50-100	1	67	Yes	1,3 +/- 20%

Metrological characteristics according to EN ISO 463, vertical position:

Measuring range indication error	Indication error at 1/10 lap	Indication error at 1/2 lap	Indication error at 1 lap	Repeatability of indication error	Hysteresis of indication error
MPE _{tot}	MPE 1/10	MPE 1/2	MPE 1	MPE _R	MPE _H
[µm]	[µm]	[µm]	[µm]	[µm]	[µm]
12 (5 mm) / 15 (10 mm)	5	9	10	3	3

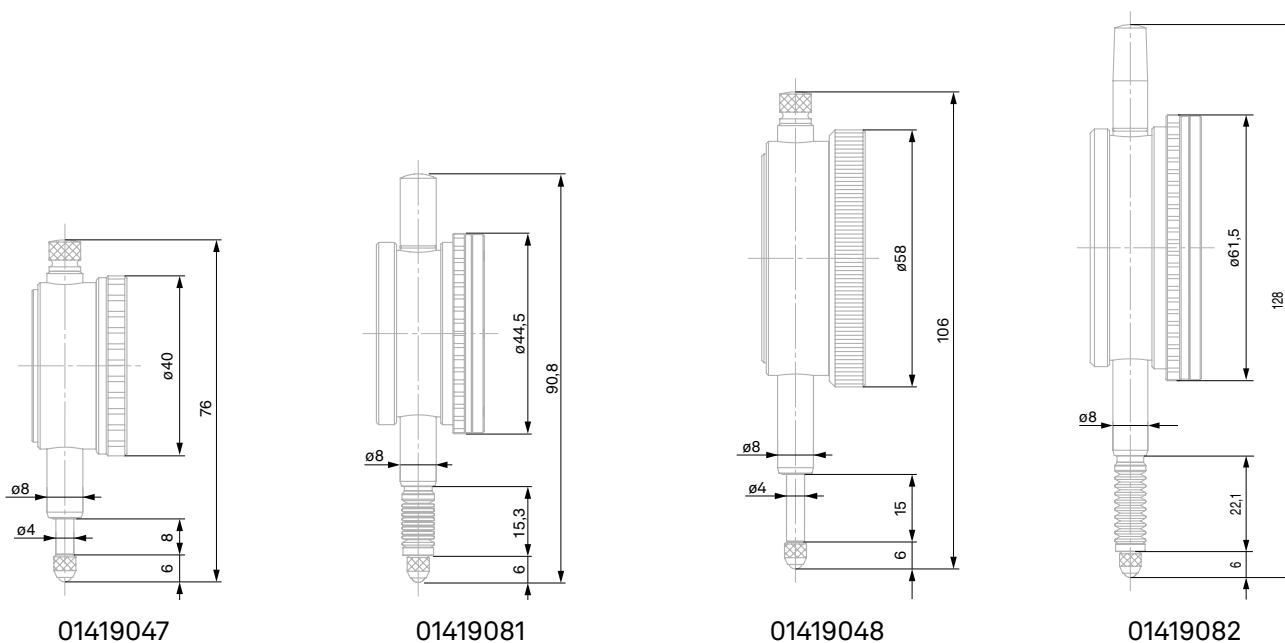

(2): To date these models existed under the ETALON brand, and are now part of the TESA brand.

Standard versions, measuring range 30 and 50 mm



0141760651



0141760661

Ø Dial [mm]	Part number	Measuring range [mm]	Circular scale	Travel/lap [mm]	Degree of protection	Shockproof system	Measuring force [N]
58	0141760651 ⁽¹⁾	30	0-50-100	1	40	Yes	0,8 +/- 20%
58	0141760661 ⁽¹⁾	50	0-50-100	1	40	Yes	1 +/- 20%

Metrological characteristics according to EN ISO 463, vertical position:

	Measuring range indication error	Indication error at 1/10 lap	Indication error at 1/2 lap	Indication error at 1 lap	Repeatability of indication error	Hysteresis of indication error
	MPE tot [µm]	MPE 1/10 [µm]	MPE 1/2 [µm]	MPE 1 [µm]	MPE _R [µm]	MPE _H (µm)
0141760651	20	5	10	15	3	5
0141760661	25	5	10	15	3	-

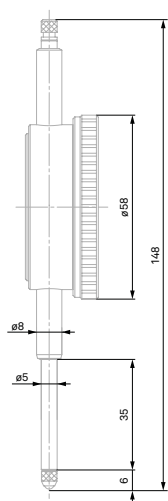

0141760651

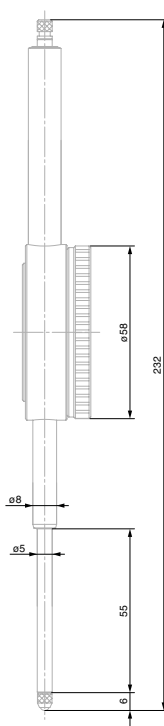

0141760661

(1): To date these models existed under the ROCH brand, and are now part of the TESA brand.

Compact version, measuring range 3,5 mm

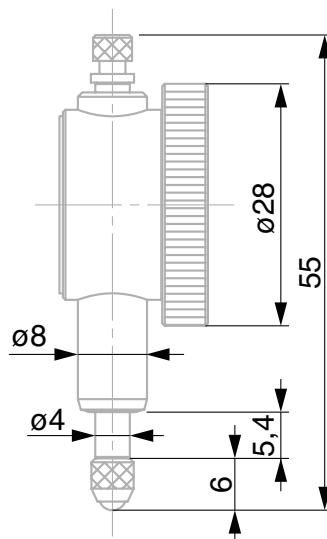

01419080

Ø Dial [mm]	Part number	Measuring range [mm]	Circular scale	Travel/lap [mm]	Degree of protection	Shockproof system	Measuring force [N]
28	01419080	3,5	0-25-50	0,5	40	No	0,8 +/- 20%

Metrological characteristics according to EN ISO 463, vertical position:

Measuring range indication error	Indication error at 1/10 lap	Indication error at 1/2 lap	Indication error at 1 lap	Repeatability of indication error	Hysteresis of indication error
MPE _{tot}	MPE 1/10	MPE 1/2	MPE 1	MPE _R	MPE _H
[µm]	[µm]	[µm]	[µm]	[µm]	[µm]
17	5	9	10	3	3



01419080



01419080

Back rod version, measuring range 3 mm



0141760566



Ø Dial [mm]	Part number	Measuring range [mm]	Circular scale	Travel/lap [mm]	Degree of protection	Shockproof system	Measuring force [N]
40	0141760566 ⁽¹⁾	3	0-25-50	0,5	40	Yes	1,5 +/- 20%

Measuring range indication error	Indication error at 1/10 lap	Indication error at 1/2 lap	Indication error at 1 lap	Repeatability of indication error	Hysteresis of indication error
MPE tot [µm]	MPE 1/10 [µm]	MPE 1/2 [µm]	MPE 1 [µm]	MPE _R [µm]	MPE _H [µm]
12	5	8	9	3	5

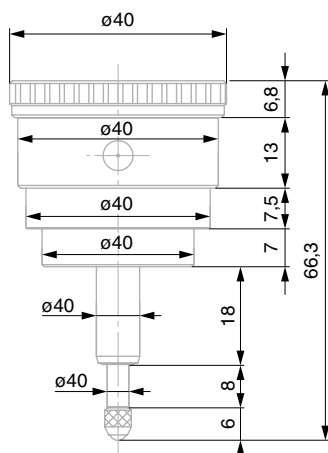

0141760566

(1): To date this model existed under the ROCH brand, and is now part of the TESA brand.

Resolution 0,002 mm

Standard version, measuring range 3 and 5 mm



01419056



01419057



01419058

Ø Dial [mm]	Part number	Measuring range [mm]	Circular scale	Travel/lap [mm]	Degree of protection	Shockproof system	Measuring force [N]
44,5	01419056	3	0-10-20	0,2	40	Yes	1,1 +/- 20%
44,5	01419057	3	0-10-20	0,2	67	Yes	1,3 +/- 20%
61,5	01419058	5	0-10-20	0,2	40	Yes	1,4 +/- 20%

Metrological characteristics according to EN ISO 463, vertical position:

Measuring range indication error	Indication error at 1/10 lap	Indication error at 1/2 lap	Indication error at 1 lap	Repeatability of indication error	Hysteresis of indication error
MPE tot [µm]	MPE 1/10 [µm]	MPE 1/2 [µm]	MPE 1 [µm]	MPE _R [µm]	MPE _H [µm]
7 (3 mm) / 10 (5 mm)	3	4	5	0.5	3

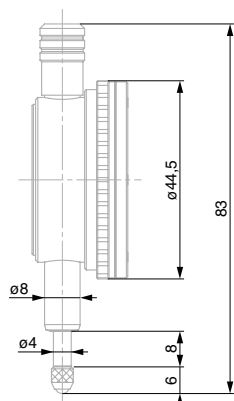

01419056

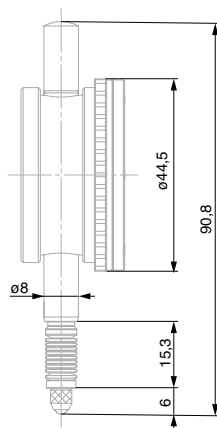

01419057

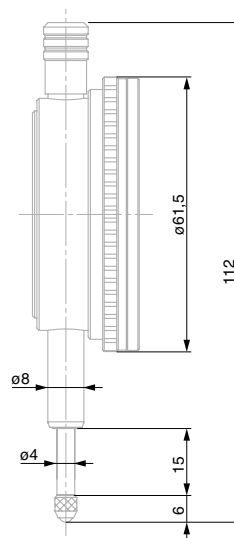

01419058

Resolution 0,001 mm

Standard version, measuring range 1 and 5 mm



01419053



01419054



01419055

Ø Dial [mm]	Part number	Measuring range [mm]	Circular scale	Travel/lap [mm]	Degree of protection	Shockproof system	Measuring force [N]
44,5	01419053	1	0-5-10	0,2	40	Yes	1 +/- 20%
61,5	01419054	1	0-10-20	0,2	40	Yes	1,4 +/- 20%
61,5	01419055	5	0-10-20	0,2	40	Yes	1,4 +/- 20%

Metrological characteristics according to EN ISO 463, vertical position:

Measuring range indication error	Indication error at 1/10 lap	Indication error at 1/2 lap	Indication error at 1 lap	Repeatability of indication error	Hysteresis of indication error
MPE tot [µm]	MPE 1/10 [µm]	MPE 1/2 [µm]	MPE 1 [µm]	MPE _R [µm]	MPE _H [µm]
5 (1 mm) / 10 (5 mm)	2	3	4	0,5	3

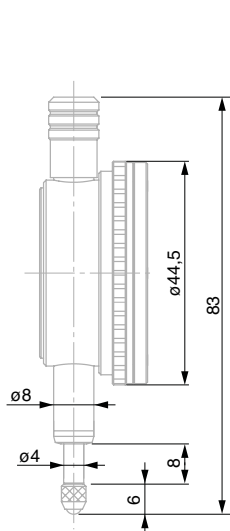

01419053

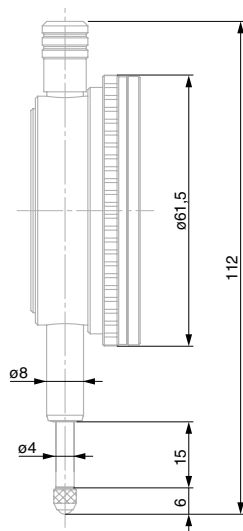

01419054

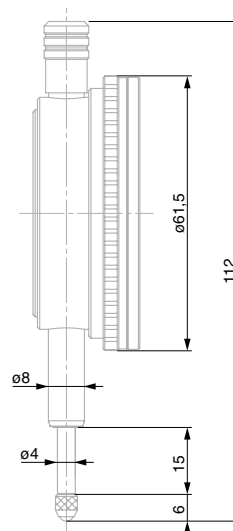

01419055

High-precision version, measuring range 0,1 mm



01419051



01419052

Ø Dial [mm]	Part: number	Measuring range [mm]	Circular scale	Travel/lap [mm]	Degree of protection	Shockproof system	Measuring force [N]
62	01419051 ⁽²⁾	0,1	50-0-50	-	40	Yes	1 +/- 20%
62	01419052 ⁽²⁾	0,1	50-0-50	-	54	Yes	1,4 +/- 20%

Metrological characteristics according to DIN 879-1, vertical position:

Measuring range indication error	Indication error at 1/10 lap	Indication error at 1/2 lap	Indication error at 1 lap	Repeatability of indication error	Hysteresis of indication error
MPE tot	MPE 1/10	MPE 1/2	MPE 1	MPE _R	MPE _H
[µm]	[µm]	[µm]	[µm]	[µm]	[µm]
1	1,2	0,5	0,7	0,5	-

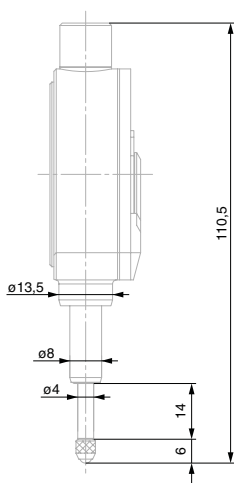

01419051

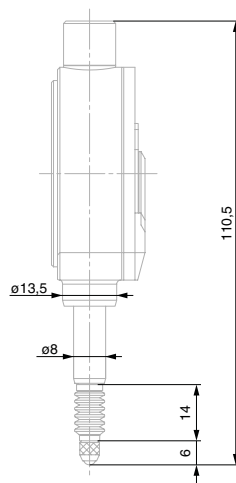

01419052

(2): To date these models existed under the ETALON brand, and are now part of the TESA brand.

Hemispherical measuring keys M2,5

Part number	Measuring face [mm]	Key length [mm]	Material
03510001	R 1,5	5	Steel
03510002	R 1,5	5	Hard metal
03510101	R 5	6	Steel
03510102	R 5	6	Hard metal
03510201	R 1,5	16/26/36/46 (interchangeable)	Steel
03560001	R 1,5	5	Sapphire
03560007	R 1,5	4	Hard metal
03560017	R 16	6	Steel
03560018	R 16	6	Hard metal
03560019	R 1,5	8	Steel
03560020	R 1,5	8	Hard metal
03560021	R 1,5	8	Ruby
03560035	R 0,5	5	Steel
03560036	R 0,5	10	Steel
03560037	R 0,5	15	Steel
03560038	R 0,5	20	Steel
03560039	R 0,5	30	Steel
03560040	R 0,5	40	Steel
03560051	D 1	18	Hard metal
03560052	D 2	18	Hard metal
03560053	D 3	18	Hard metal
03560054	D 4	18	Hard metal
03560055	D 5	18	Hard metal
03560056	D 6	18	Hard metal
03560057	D 7	18	Hard metal
03560058	D 8	18	Hard metal

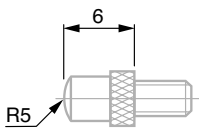

03510101-102

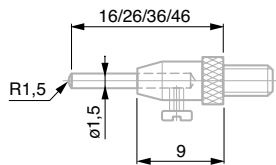

03510201

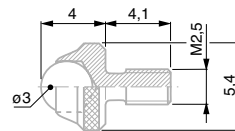

03560007

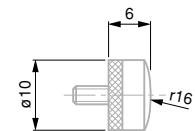

03560017-18

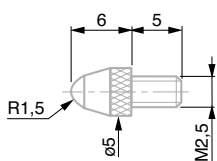

03510001-2, 03560001

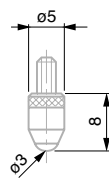

03560019-20-21

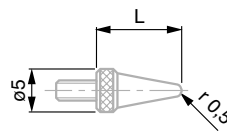

03560035-36-37-38-39-40

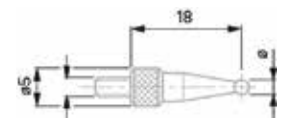

03560051-52-53-54-55-56-57-58

Inserts with flat measuring face M2.5

Part number	Diameter [mm]	Probe length [mm]	Mounting [mm]	Material	Remark
03510902	4	16	M2,5	Hard metal	Adjustable parallelism
03560008	1,5	20	M2,5	Steel	Interchangeable pin
03560009	1,5	20	M2,5	Hard metal	Interchangeable pin
03510801	2,5	6	M2,5	Steel	
03510802	2,5	6	M2,5	Hard metal	
03560022	3,4	6	M2,5	Steel	
03560023	3,4	6	M2,5	Hard metal	
03560026	2	2,8	M2,5	Steel	
03560027	2	7,8	M2,5	Steel	
03560028	2	12,8	M2,5	Steel	
03560029	2	17,8	M2,5	Steel	
03560012	5	5	M2,5	Steel	
03560013	5	5	M2,5	Hard metal	
03560014	10	6	M2,5	Steel	
03560015	10	6	M2,5	Hard metal	
03560016	20	3,6	M2,5	Steel	

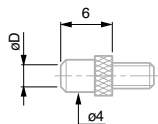

03510801-802, 03560022-23

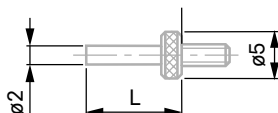

03560026-27-28-29

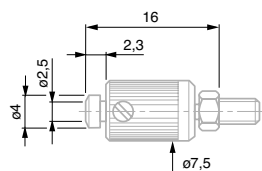

03510902

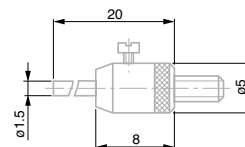

03560008-9

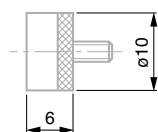

03560014-15

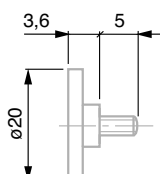

03560016

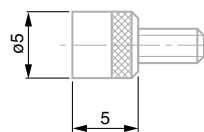

03560012-13



03560012-13

Supports



01639007

Magnetic support



01639023

Magnetic support with articulated arm



01639017

Table measuring support with ground table surface



01639035

Holder with granite class 00

| For more models, visit tesatechnology.com

Application examples

Bore checking by comparison against a setting ring



Checking parts against a reference

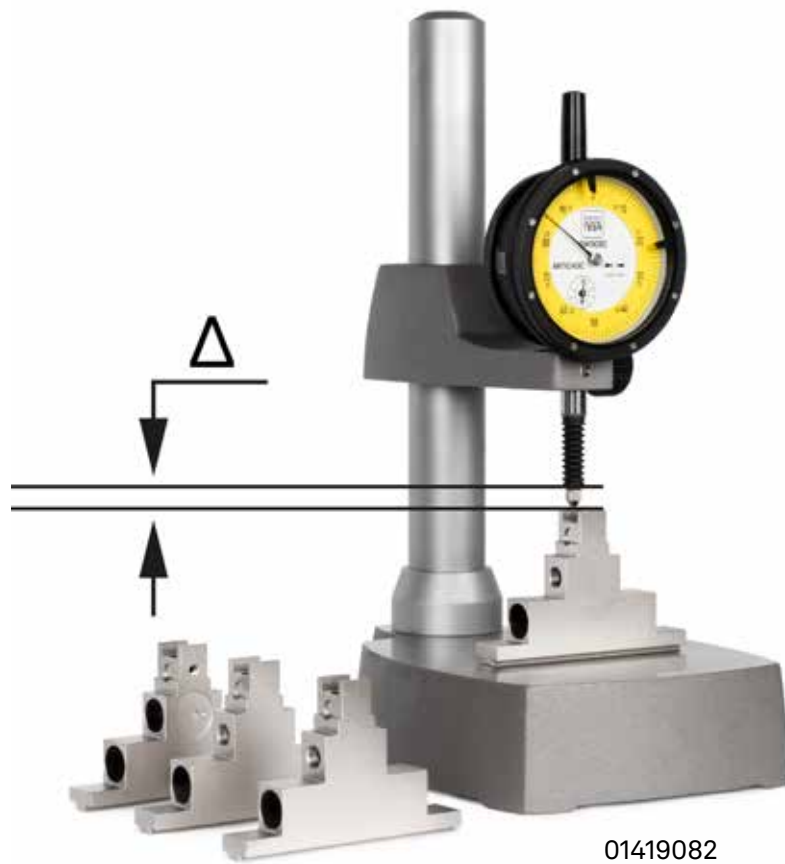

Run-out measurement directly on the machining tower



Parallelism measurement on marble



01419048

Assembly control on specific assembly



01419054

Range at a glance

Ø Dial [mm]	Part number	Model type	Resolution [mm]	Measuring range [mm]	Shockproof system	Degree of protection
28	01419080	compact	0,01	3,5	-	IP40
40	0141760500	standard	0,1	10	-	IP40
40	01419047	standard	0,01	5	●	IP40
44,5	01419081	standard	0,01	5	●	IP67
40	0141760566	back rod	0,01	3	-	IP40
44,5	01419056	standard	0,002	3	●	IP40
44,5	01419057	standard	0,002	3	●	IP67
44,5	01419053	standard	0,001	1	●	IP40
58	0141760501	standard	0,1	10	-	IP40
58	01419048	standard	0,01	10	●	IP40
61,5	01419082	standard	0,01	10	●	IP67
61,5	01419058	standard	0,002	5	●	IP40
61,5	01419054	standard	0,001	1	●	IP40
61,5	01419055	standard	0,001	5	●	IP40
58	0141760503	long travel	0,1	30	-	IP40
58	0141760651	long travel	0,01	30	-	IP40
58	0141760661	long travel	0,01	50	-	IP40
62	01419051	high precision	0,001	0,1	-	IP40
62	01419052	high precision	0,001	0,1	-	IP54



About Hexagon and TESA

Hexagon is a global leader in sensors, software and autonomous solutions. We are putting data to work to boost efficiency, productivity, and quality across industrial, manufacturing, infrastructure, safety, and mobility applications.

Our technologies are shaping urban and production ecosystems to become increasingly connected and autonomous – ensuring a scalable, sustainable future.

TESA Technology, part of Hexagon's Manufacturing Intelligence division, is a leading innovator and manufacturer of precision measuring instruments, long established in Switzerland. For more information, visit tesatechnology.com. Hexagon's Manufacturing Intelligence division provides solutions that utilise data from design and engineering, production and metrology to make manufacturing smarter.

For more information on Hexagon (Nasdaq Stockholm: HEXA B) visit hexagon.com and follow us @HexagonAB.